

Chapter 4 Information Integration



Outline

- Information Integration Tasks
- Schema Matching
 - Classification of Approaches
 - Example: Cupid
- Schema Merging
 - Example: Rondo
- Integration Planning
 - Example: Clio
- Deployment
 - Example: Orchid
 - Incremental loading of DW
- Model Management
- Information integration in dynamic environments
 - Dynamic II
 - Change impact analysis
- Data Integration
 - Data Quality Problems
 - Causes and Consequences
 - Data Cleaning Approaches



Bridging/Resolving Heterogeneity

- Real-world integration scenarios suffer from all kinds of heterogeneity
- Techniques and concepts already discussed in previous chapters and the primary issues they address:
 - Wrappers (data model heterogeneity, technical heterogeneity, syntactic heterogeneity)
 - Garlic (technical heterogeneity, structural heterogeneity, distribution)
 - Multi-database languages (schematic heterogeneity, technical heterogeneity, distribution)
 - SQL/XML (data model heterogeneity)
 - DB Gateways (technical heterogeneity)
 - ETL tools (structural heterogeneity, technical heterogeneity, syntactic heterogeneity)
⇒ focus on data access/transformation infrastructure (i.e., as a runtime platform)
- Further techniques discussed in this chapter
 - Schema Matching and Integration (semantic heterogeneity, structural heterogeneity)
 - Data Cleaning/Fusion (syntactic heterogeneity, semantic heterogeneity (in data))
⇒ focus on integration planning



Information Integration Tasks

- Information integration subsumes numerous tasks (and has numerous names for most of them...):
 1. Schema Merging/Schema Integration
 2. Design of the integrated target schema
 3. Schema Matching/Schema Mapping
 4. Integration Planning/Schema Mapping/Schema Integration/Mapping Generation/Mapping Interpretation
 5. Data Cleaning
 6. Data Fusion/Record Matching/Entity Resolution/Instance Disambiguation
 7. Wrapping/Data model transformation
 8. Deployment/Integration Plan Implementation



Information Integration Phases [Gö05b]

- Analysis – Determine the requirements on the integrated schema:
 - Desired data model, integration strategy (virtual or materialized)
 - Relevant data (which application concepts should be present)
- Discovery – Find/identify relevant data sources
 - In classical scenarios sources are often known implicitly
 - Challenging aspect of → Dynamic information integration
- Planning – Resolve heterogeneity
 - Technical heterogeneity (enable access to sources)
 - Semantic heterogeneity → Schema Matching
 - Data model, structural and schematic heterogeneity
 - develop data transformation specification (integration plan)
- Deployment
 - Set up integration plan in a runtime environment that provides the integrated data
 - e.g., federated DBMS, data warehouse, stylesheets, scripts
- Runtime
 - React to changes in the data sources/requirements



Information Integration Approaches

- Bottom-up design
 - Used to completely integrate a well-known set of data sources
 - Assumes that changes of the number and properties of the data sources are rare
 - Integrated schema is created based on the data sources (→ *Schema Merging*)
 - No distinguished discovery and analysis phases
 - Common in enterprise integration scenarios
- Top-down design
 - Used when the available data sources are not known a priori
 - The number and properties of candidate data sources for integration are changing constantly
 - Integrated schema is designed independently from the sources, based only on the application requirements
 - Analysis phase precedes discovery phase
 - *Dynamic Information Integration*
- Hybrid design
 - Selection of data sources based on requirements
 - Design of integrated schema influenced by requirements and data source schemas
 - Analysis and discovery are intertwined



Schema Matching



Schema Matching

- Goal: Identify semantically related elements across different schemas
- Schema element: table, column, element, attribute, class, etc.
- Result: set of *matches* or (*value correspondences* (a *mapping*))
- Essential preparation step for most subsequent integration tasks
- Different expressiveness of correspondences
 - Match Degree (also: *local cardinality*)
 - 1:1 semantic relationship of one element of schema A with one element of schema B
 - 1:n semantic relationship of one element of schema A with a set of elements of schema B
 - n:m semantic relationship between sets of elements from schemas A and B
 - Match Semantics
 - Basic matches do not carry additional semantics, they only indicate "some relationship"
 - Advanced matches can indicate abstraction concepts (inheritance, composition, etc.) or functions (e.g., "A is equivalent to the sum of B₁ and B₂")
- "Higher order" correspondences
 - Connect different types of schema elements (e.g. a department table corresponding to a department attribute)
 - Connect metadata with data (e.g., categorical attributes)
- Does *not* refer to the relationship between the instances of the matched concepts (e.g. instances are identical/subsumed/disjoint/overlap)



Schema Matching – Terminology Disambiguation

- Mapping
 - **A set of correspondences between two schemas**
 - The process of creating a set of correspondences (→ schema matching, see below)
 - But also
 - A function or transformation describing how data is transformed (→ Integration plan)
 - The process to create a function/transformation (→ Integration planning)
- Schema Matching
 - **The process of obtaining a mapping**
 - An *automatic* process to obtain a mapping



Schema Matching – Challenges

- Identification of matches difficult
 - Very large schemas (10^2 - 10^3 relations, 10^3 - 10^4 attributes)
 - Complex schemas
 - Initially unknown and undocumented schemas
 - Ambiguities (Synonyms, Hypernyms, Abbreviations, ...)
 - Foreign languages
 - Cryptic identifiers
- Time-consuming and expensive
 - Element-wise “comparing” a schema A with n elements with a schema B with m elements requires $n \cdot m/2$ comparisons
 - For $n \approx m$: $O(n^2)$
 - Even higher complexity if sets of elements are compared ($O(2^{2n})$), e.g. to obtain 1:n/n:m matches → practical approaches limit sets to a maximum size k
- Numerous approaches to automate schema matching
 - Error-prone (false-positives and false-negatives)
 - At best semi-automatic (for good results, domain experts must review, amend and revise matches)
 - Used as a preparation step for a human domain expert to reduce search space



Schema Matching – Classification of Approaches

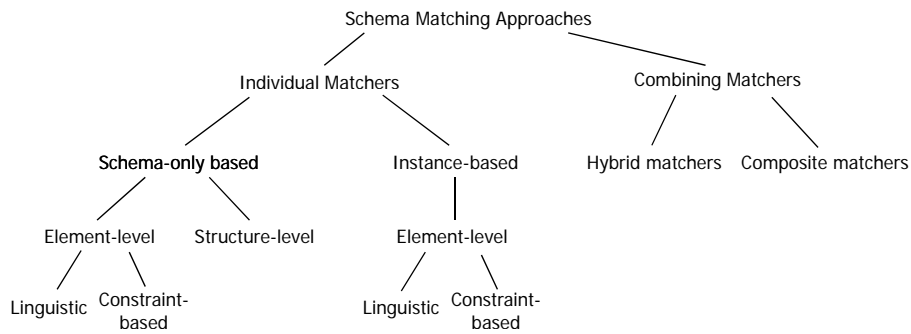

based on [RaBe01]



© Prof. Dr.-Ing. Stefan Deßloch

11

Enterprise Information Systems

Individual vs. Combining Matchers

- Individual matchers exploit only one kind of information for identifying matches
- Combining matchers use several:
 - Hybrid:
 - Different approaches “hard-wired” into one (parameterizable) component to create a single mapping between the schemas
 - Reuse of individual elements in combination with other matchers or extension with new concepts and approaches to matching is difficult
 - Composite
 - Retroactively combine mappings from different (individual and combining) matchers
 - Common methods: (weighted) average, max, min

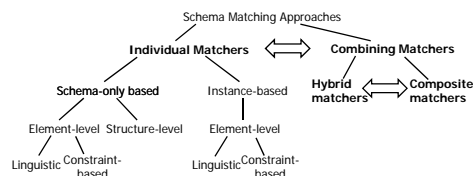

© Prof. Dr.-Ing. Stefan Deßloch

12

Enterprise Information Systems

Schema-only vs. instance-based matching

- Schema-only techniques operate solely on metadata:
 - table/column/element/attribute/... identifiers and comments or annotations
 - data types
 - constraints
 - element structuring
- Instance-based techniques also consider properties of the data
 - Can only be used *among* data sources
 - In order to use with target schema, sample data can be provided
 - Uses statistical information on data values
 - Actual value ranges of attribute values (e.g., ints in the interval [0,120])
 - Enumeration of values actually present in the data
 - Histograms (Number of occurrences of individual attribute values)
 - Regular expressions describing value patterns (e.g. [0..9]{5} for German zip codes)

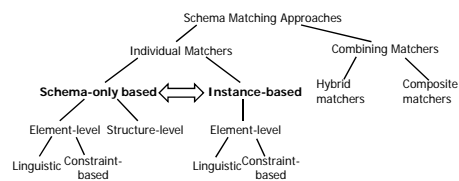

© Prof. Dr.-Ing. Stefan Deßloch

13

Enterprise Information Systems

Linguistic Matching – String Similarity

- String distance or similarity measures [CRF03]
- Based on the lexical similarity of schema element identifiers
- Often used after applying string preprocessing techniques
 - Tokenization: split identifiers based on case, punctuation, etc.
 - Stemming: reduce identifiers to word stem (e.g. "computer" → "comput")
Note: Stemming algorithms are language-dependent (for English: Porter's algorithm)
 - Stopword elimination
- Edit-distance-like functions, e.g.
 - Levenshtein distance:
 - Count the number of edit operations (insert, modify, delete) to turn string a into string b
 - Example:
kitten
sitting
→ 2 replacements, 1 insertion $\text{LevenshteinDist}(\text{"kitten"}, \text{"sitting"}) = 3$
 - Weighting of operations possible (e.g. replace more expensive than delete)
 - Normalization to interval [0,1] by dividing result through $\max(\text{length}(\text{String A}), \text{length}(\text{String B}))$
 - Other measures: Monge-Elkan, Jaro-Winkler, ...



© Prof. Dr.-Ing. Stefan Deßloch

14

Enterprise Information Systems

Linguistic Matching – String Similarity (cont.)

- Token-based functions, e.g.
 - Applied on sets of tokens of identifiers
 - Tokenization based on word separators (white space, punctuation, special characters, case)
 - e.g. "Web-of-trust" → {"Web", "of", "trust"}, "CamelCaseIdentifier" → {"Camel", "Case", "Identifier"}
 - Tokenization based on n-grams
 - Tokens created by sliding a window of size n over the string
 - e.g. 3-grams for "Information" → {"Inf", "nfo", "for", "orm", "rma", "mat", "ati", "tio", "ion"}
 - Jaccard similarity – describes the similarity of two sets

$$\text{JaccardSimilarity}(A, B) = \frac{|A \cap B|}{|A \cup B|}$$
 - Example:
 - ProductPrice → A = {Product, Price}, PriceOfProduct → B = {Price, Product, Of}
 - JaccardSimilarity(A, B) = 2/3
 - TFIDF (Term frequency/inverse document frequency) methods
 - Measure originally developed for information retrieval
 - Here: document = (tokenized) identifier, term = token
 - Determines a weight $w_s(t)$ for each token t of a string S based on its frequency in the identifier (term frequency, $tf_s(t)$) and the inverse of its frequency in all identifiers (inverse document frequency, $idf(t)$)
 - Idea: Tokens occurring frequently in the string S have a high weight, while tokens occurring in almost every string receive a low weight
 - Basic weight formula: $w_s(t) = tf_s(t) \cdot idf(t)$



Linguistic Matching – String Similarity (cont.)

- TFIDF (continued)
 - Many different approaches to calculate $tf_s(t)$ and $idf(t)$
 - e.g., with $n_{s,x}$ being the number of occurrences of term x in document S, T being the set of all terms in S, N being the total number of documents, and N_t being the number of documents that contain term t (at least once):

$$tf_s(t) = \frac{n_{s,t}}{\max_{i \in T}(n_{s,i})} \quad idf_s(t) = \log_e \left(1 + \frac{N}{N_t} \right)$$
 - Identifiers can be interpreted as vectors in n-dimensional space (with n being the number of different tokens), with the term weights $w_s(t)$ as vector components/elements
 - The similarity between the identifiers is the similarity of the direction (ignoring length) of their respective vectors, i.e., the greater the angle between their vectors, the smaller the similarity
 - Applying the cosine on the angle, we normalize the difference in angle to [0,1]: for an angle of 0°, the cosine is 1 (maximum similarity), for an angle of 90° the cosine is 0
 - Then the similarity function between two identifiers S_1 and S_2 is defined using the cosine measure

$$\text{cosine}(S_1, S_2) = \frac{\sum_{t=1}^n w_{s_1} \cdot w_{s_2}}{\sqrt{\sum_{t=1}^n w_{s_1}(t)^2} \cdot \sqrt{\sum_{t=1}^n w_{s_2}(t)^2}}$$

- Hybrid approaches
 - use a secondary similarity function to determine similarity between tokens
- Problem of all approaches based on lexical similarity:
 - Lexical similarity does not necessarily indicate semantic similarity! (and v.v.)



Linguistic Matching – Ontology-based approaches

- Use a Dictionary/Thesaurus/Ontology¹ to store knowledge about application domain terms and concepts and their relationships, e.g.
 - Synonymy
 - Hypo/hypernymy, sub/superclasses
 - Aggregation
 - Opposite terms/concepts
- Can contain alternative forms for terms (word stem, abbreviations)
- Distance of two terms within the thesaurus is translated to similarity value
- Can be extended to handle different languages
- Ontologies can be domain-specific or generic and vary in the level of detail
 - Design of a good ontology is a daunting task
 - Depending on their specific point of view and their level of detail, ontologies will often disagree on terms and their relationships, e.g.:
Is "car" a special type of "vehicle" (hyponym), or are the terms synonyms?



¹ These and similar terms are not used consistently throughout the literature.
See e.g. <http://www.metamodel.com/article.php?story=20030115211223271> for an attempt at a definition of these terms.

Structural Schema Matching

- Exploit the relationships (structure) among schema elements to improve the quality of matches
- Usually require an initial set of correspondences provided by (non-structural) schema matchers
 - ➔ Practical implementations are usually hybrid matchers (although they could be built as combining matchers)
- Examples:
 - Cupid [MBR01]
 - Similarity Flooding [MGR02]



Cupid

- Developed by Microsoft Research [MBR01]
- Hybrid approach:
 - Element-based: linguistic and data type similarity
 - Structure-based: *TreeMatch* algorithm
- Three phases
 - Linguistic matching
 - Determine initial matches based on schema element identifiers
 - Structure matching
 - Modify initial values based on element structure
 - Creation of mappings/matches
 - Choose the matches to return as result
 - Method depends on the intended use for the matches, e.g.
 - Prune matches below a given threshold
 - Return only leaf-level matches



Cupid Linguistic Matching

1. Normalization
 - Tokenization: split identifiers into tokens based on punctuation, case, etc.
e.g. POBillTo \Rightarrow {PO, Bill, To}
five token types: number, special symbol, common word, concept, content
 - Expansion: expand acronyms with the help of a thesaurus/dictionary
e.g. Qty \Rightarrow Quantity
 - Elimination: discard prepositions, articles, etc. with the help of a stop word list
e.g. {PO, Bill, To} \Rightarrow {PO, Bill}
 - Tagging: identifiers related to a known application concept are tagged with the concept
e.g. identifiers *Price*, *Cost* and *Value* are tagged with the concept *Money*
2. Categorization
 - Clusters elements into categories (= a group of elements identified by a set of keywords)
 - Goal: reduce comparisons to only those elements within compatible categories
 - One category for each:
 - Concept tag
 - Data type (coarse grained, e.g., number, string, date, ...)
 - Container (e.g., address contains city, state, and street)
 - Elements can belong to multiple categories
 - Categories are compatible, if their respective sets of keywords are "name similar"



Cupid Linguistic Matching (cont.)

- Name similarity:
 - The *name similarity* of two token sets T_1 and T_2 is the average of the best similarity of each token in set T_1 with a token in set T_2
 - To determine the similarity of two tokens t_1 and t_2 , a thesaurus lookup is performed
 - If no thesaurus entry is present for a pair of tokens, substring matching is used to identify common pre- and suffixes
- 3. Comparison
 - Determines the linguistic similarity coefficient $lsim(s,t)$ $s \in S, t \in T$, for pairs of elements of the two schemas S and T
 - For each pair of elements s, t from compatible categories
 1. Calculate the name similarity of the element tokens *per token type*
 2. Calculate the weighted mean of the per-token-type name similarity (concept and content tokens are assigned a higher weight)
 3. Calculate $lsim$ for the pair by scaling the result of 2. with the maximum name similarity of the categories of s and t
 - Result: a table of linguistic similarity coefficients $lsim(s,t)$ in the range $[0,1]$



Cupid Linguistic Matching – Problems

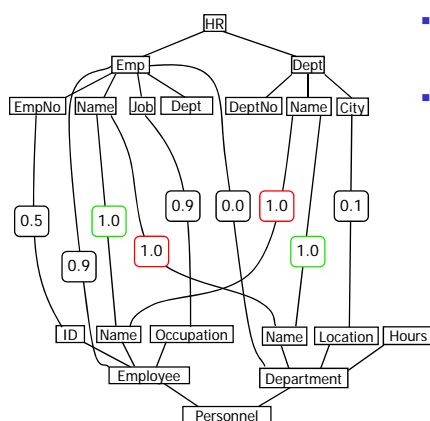

(not all matches shown)

- Linguistic matching does not consider context:
e.g., false positive: Emp/Name is as similar to Employee/Name as it is to Department/Name
- Linguistically dissimilar, but semantically related elements are underrated (caused by missing or incomplete thesaurus)
e.g. Dept/City – Department/Location



Cupid Structural Matching

- Based on a tree representation of the structure of the schema
- *TreeMatch* algorithm
- Basic intuitions
 1. A pair of leaves from two trees is similar, if
 - a) they are individually similar (linguistic, data type, ...)
 - b) their neighbors (ancestors and siblings) are similar
 2. A pair of non-leaves is similar, if
 - a) they are linguistically similar
 - b) their subtrees are similar
 3. A pair of non-leaves is structurally similar, if their respective leaves are highly similar (not necessarily their direct children)
- Initialize *ssim* for all leaves using a data type compatibility matrix (range [0,0.5])
- *Stronglink*: similarity between two leaves is above threshold th_{accept}
 - based on weighted similarity (see next chart)



Cupid Structural Matching (cont.)

- Iterate over the tree nodes in post-order (bottom-up calculation)
- For each pair s, t :
 - Calculate $ssim(s, t)$ as the fraction of leaves in the two subtrees below s and t that have at least one stronglink to a leaf in the other subtree
 - Calculate a weighted similarity measure $wsim(s, t)$:
$$wsim(s, t) = w_{struct} \cdot ssim(s, t) + (1 - w_{struct}) \cdot lsim(s, t)$$
 - If $wsim(s, t)$ is above threshold th_{high} , increase the similarity of each pair of leaves in the subtrees of s and t by a factor c_{inc} (not exceeding 1)
 - If $wsim(s, t)$ is below threshold th_{low} , decrease the similarity of each pair of leaves in the subtrees of s and t by a factor c_{dec} (but never below 0)



Cupid Structural Matching – Example

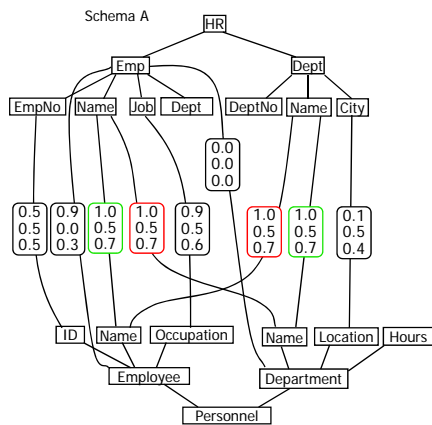

- Initialization:
 - ssim set to 0.0 for all non-leaf nodes
 - ssim set to data type similarity for leaves
- Parameters:
 - $th_{accept} = 0.5$
 - $w_{struct} = 0.7$
 - $th_{high} = 0.7, c_{inc} = 1.2$
 - $th_{low} = 0.3, c_{dec} = 0.8$

Schema B

(not all matches shown)

Isim
ssim
wsim



© Prof. Dr.-Ing. Stefan Deßloch

25

Enterprise Information Systems

Cupid Structural Matching – Example (cont.)

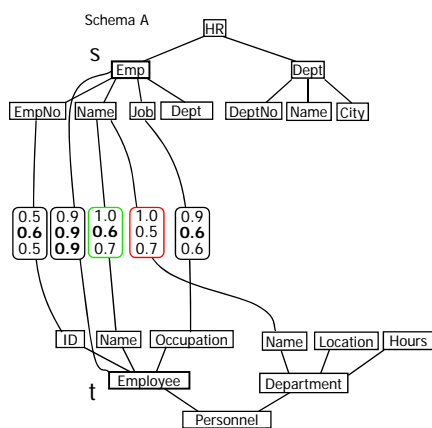

Schema B

Isim
ssim
wsim



© Prof. Dr.-Ing. Stefan Deßloch

26

Enterprise Information Systems

- Iteration for $s = \text{Emp}, t = \text{Employee}$:
 - Calculate ssim:
 - 3 out of 4 leaves of Emp have stronglinks to leaves of Employee, 3 out of 3 leaves of Employee have stronglinks to Emp
 - $ssim(s,t) = 6/7 \approx 0.9$
 - Calculate wsim:
 - $wsim(s,t) = w_{struct} \cdot ssim(s,t) + (1-w_{struct}) \cdot Isim(s,t)$
 - $= 0.7 \cdot 0.9 + 0.3 \cdot 0.9 = 0.9$
 - Modify structural similarity for leaves of s and t:
 - $wsim(s,t) = 0.9 > th_{high} = 0.7$
 - \Rightarrow increase ssim for each pair (l_s, l_t) , $l_s \in \text{leaves}(s)$ and $l_t \in \text{leaves}(t)$:
 - $ssim_{new}(l_s, l_t) = ssim_{old}(l_s, l_t) \cdot c_{inc} = 0.5 \cdot 1.2 = 0.6$ (wsim for leaf-pairs is left unchanged)
- Result:
 - Similarity between s and t increased, because children are similar (intuitions 2b and 3)
 - Similarity between the child nodes increased, because their neighbors (here: ancestors) are similar (intuition 1b)

Cupid Structural Matching – Example (cont.)

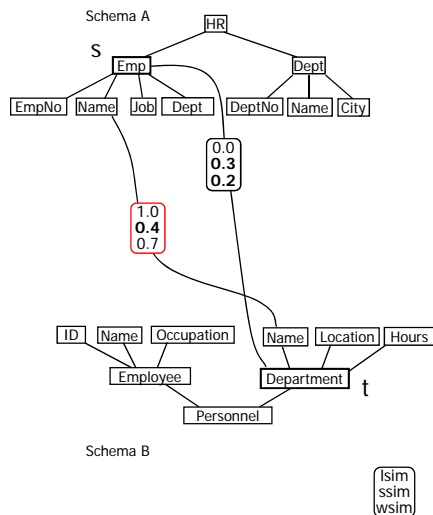

- Iteration for $s = \text{Emp}$, $t = \text{Department}$:
 - Calculate ssim :
 $\text{ssim}(s,t) = 2/7 \approx 0.3$
 (1 out of 4 leaves of Emp have stronglinks to leaves of Department, 1 out of 3 leaves of Department have stronglinks to leaves of Emp)
 - Calculate wsim :
 $\text{wsim}(s,t) = w_{\text{struct}} \cdot \text{ssim}(s,t) + (1-w_{\text{struct}}) \cdot \text{lsim}(s,t)$
 $= 0.7 \cdot 0.3 + 0.3 \cdot 0.0 = 0.21 \approx 0.2$
 - Modify structural similarity for leaves of s and t :
 $\text{wsim}(s,t) = 0.2 < \text{th}_{\text{low}} = 0.3$
 \Rightarrow decrease ssim for each pair (l_s, l_t) ,
 $l_s \in \text{leaves}(s)$ and $l_t \in \text{leaves}(t)$:
 $\text{ssim}_{\text{new}}(l_s, l_t) = \text{ssim}_{\text{old}}(l_s, l_t) \cdot c_{\text{dec}}$
 (wsim for leaf-pairs is left unchanged)
- Result:
 - Similarity between Emp/Name and Department/Name decreased, because their ancestors are not similar



© Prof. Dr.-Ing. Stefan Deßloch

27

Enterprise Information Systems

Cupid – Summary

- TreeMatch exploits a schema element's context to modify similarity values
- Helps to discern between pairs that were rated identical by linguistic matching:
 - Confidence of false positives reduced:
 - Match confidence between leaves with dissimilar ancestors decreases
 - Match confidence of linguistically similar non-leaves with different children decreases
 - Confidence of false negatives or uncertain matches increased
 - Match confidence of leaf-pairs with similar ancestor increases
 - Match confidence of linguistically dissimilar non-leaves with similar children increases



© Prof. Dr.-Ing. Stefan Deßloch

28

Enterprise Information Systems

Schema Integration



Schema Integration

- Goal: Create an integrated schema T from a set S of schemas that is:
 - complete (contains all concepts of S)
 - minimal (contains semantically equivalent concepts only once)
 - correct (each concept must correspond to a concept of at least one source)
 - intelligible (humans can understand the schema, e.g., names of concepts and their attributes should be preserved where possible)
- Schema Integration is *not* about transforming data from one schema to another (→ Information integration, data fusion)
- Also known as schema (or ontology) merging
- Can be separated into four phases [BLN86]:
 - Preintegration
 - Choose schemas to integrate
 - Collect additional information (e.g., documentation of data sources)
 - Comparing the schemas
 - Schema Matching
 - Identify conflicts



Schema Integration (cont.)

- "Conforming" the schemas
 - Resolve conflicts, e.g., by renaming attributes, restructuring (e.g., (de-)normalization))
 - At the end of the phase, identical concepts are represented identically in all schemas
- Schema Merging and Restructuring
 - Superimpose schemas
 - Restructure to meet the four goals
- Two main categories:
 - Binary approaches integrate exactly two schemas
 - n-ary approaches integrate an arbitrary number of schemas in one step
- For binary approaches, the sequence in which they are applied to the n input schemas can make a difference
- Most approaches are not algorithms, but guidelines
 - Even algorithms require manual conflict resolution
 - At best semi-automatic
- Examples:
 - Rondo Merge Operator [PoBe03]
 - Generic Integration Model (GIM) [ScSa05]



Rondo Merge Operator – Schema Representation

- A **model** L is a triple $(E, Root, Re)$, with E being a set of **elements**, $Root \in E$ being the root element of the model, and Re being the set of **relationships** of the model
- Elements with required **properties** *name* and an internal *ID*
- Binary, directed relationships $R(x,y)$ with **cardinality constraints** and five different **kinds**:
 - Associates $A(x,y)$ – elements x and y are associated in a (not further specified) manner
 - Contains $C(x,y)$ – element x (container) contains element y (containe) (Containment)
 - Containees cannot exist on their own (i.e., delete on the container cascades to the containees)
 - transitive and acyclic
 - Has-a $H(x,y)$ – element x has a subelement y (Aggregation)
 - weaker than contains: no cascading of deletes, cycles allowed
 - Is-a $I(x,y)$ – x is a specialization of y (Specialization/Generalization)
 - transitive and acyclic
 - Type-of $T(x,y)$ – x is of type y
 - an element can be of at most one type (*one-type restriction*)



Rondo Merge Operator (cont.)

- Metamodel-specific *relationship implication rules* to infer implicit relations based on explicit relations, e.g.
 - If $T(q,r)$ and $I(r,s)$, then $T(q,s)$ – an element q of type r is implicitly also an instance of any of r 's superclasses s
 - If $I(p,q)$ and $H(q,r)$, then $H(p,r)$ and If $I(p,q)$ and $C(q,r)$, then $C(p,r)$ – an element inherits aggregates and components from its superclasses
- Mappings (=sets of correspondences) are themselves models
 - Contain mapping elements (two kinds: equality and similarity)
 - Contain mapping relationships $M(x,y)$, indicating that mapping element x represents element y
 - All model elements y represented by a single mapping element via $M(x,y)$ are said to *correspond* to one another



Rondo Merge Operator Requirements

- Inputs:
 - Two models A and B
 - A mapping Map_{AB} (=set of correspondences) between A and B
 - Optional: an indication which model is the preferred one
- Output: a merged model G
- Merge semantics based on *Generic Merge Requirements*
 1. Each element e with $e \in A \cup B \cup \text{Map}_{AB}$ corresponds to exactly one element e' in G (**Element preservation**)
 2. Two input elements are only mapped to the same element in G if the mapping indicates that they are equal (**Equality preservation**)
 3. Each input relationship is represented directly in G or implied by G (according to the rules of the metamodel) (**Relationship preservation**)
 4. Elements which are similar (but not equal) according to Map_{AB} , remain separate in G and are related by a relationship (**Similarity preservation**)
 5. No other elements besides those specified in rules 1-4 exist (**Extraneous item prohibition**)
 6. An element e in G has a property p if it has a corresponding element e' in A or B that has property p (**Property Preservation**)



Rondo Merge Algorithm

- Form **groups of elements** for which an equality mapping exists (directly or transitively)
 - Groups include the mapping elements themselves
- For each group I, **create an element** e in G:
 - ID(e) is set to an unused ID value
 - For other properties p of e, p's value v is in **order of precedence**:
 1. the value of property p of a **mapping element** in I for which property p is defined, otherwise
 2. the value of property p of an element in I of the **preferred model** for which p is defined, otherwise
 3. the value of property p of **any element** of I for which p is defined.
 - If more than one value is possible in 1-3, one is chosen arbitrarily
 → Values of mappings take precedence over those of the preferred model over those of the other model
- For each pair of elements e' and f' in G that correspond to different groups E and F
 - if for any two e ∈ E and f ∈ F a relationship R(x,y) of kind t exists in A resp. B
 - **create a relationship** R(e',f') of kind t in G
 - Relationships between elements of the same group are ignored
 - **Remove implied relationships** until a mincover remains
- Resolve **conflicts**



Merging Example

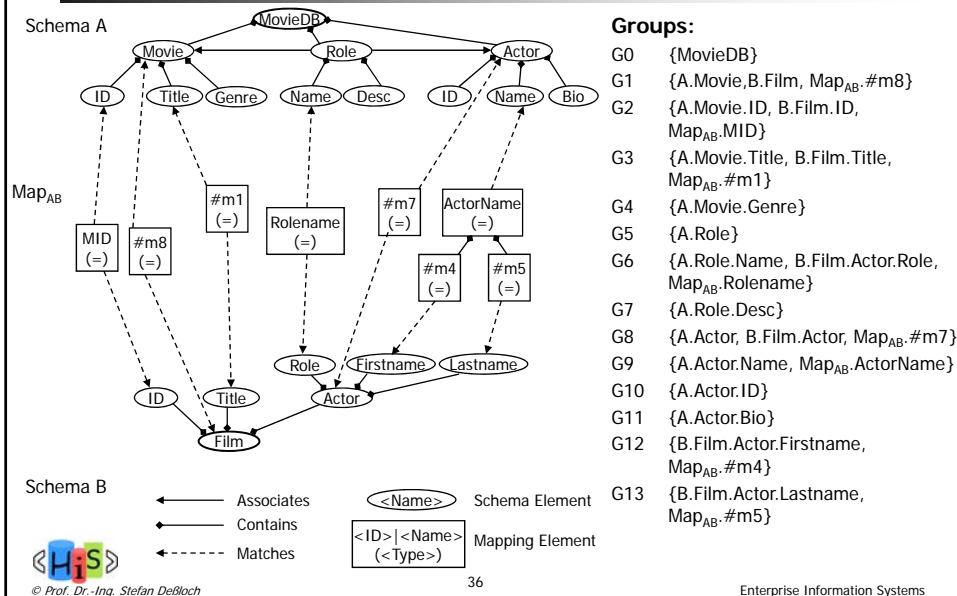

Merging Example (cont.)

- Merge(A,B, Map_{AB}) with A as the preferred schema
 - One element for each group
 - replicate all associations between members of the groups as associations between the new elements

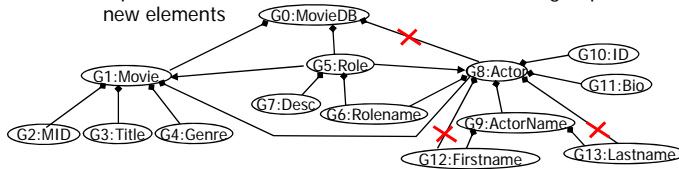

- Remove implied relationships to obtain minimum coverage of associations



Conflict resolution

- Fundamental conflicts (shared across all metamodels)

- e.g. One-type restriction violated

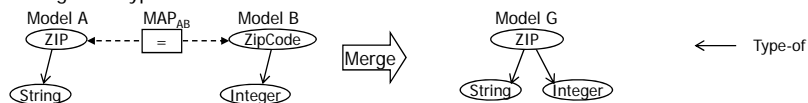

- Resolve e.g. by introducing a new type that inherits from both Integer and String



- Metamodel conflicts

- Metamodel-dependent resolution rules
- e.g., in most data models, an element can be contained in at most one container
 - e.g. Rolename in the example
 - remove one containment relationship
- SQL92 does not have the concept of subcolumn (as needed for name(firstname, lastname))

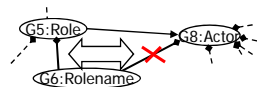

Integration Planning



Integration Planning – Goals

- Creation of an “executable mapping”, i.e., a data transformation from source to target schemas
- Inputs
 - Source schemas (and data)
 - Target schema (and sample data)
 - (Correspondences)
- Output
 - An “executable mapping”, i.e., a specification for data transformation from the sources to the target schema
 - e.g. SQL(/XML) queries/views, ETL scripts, XQuery statements etc.
 - Usually created manually with tool support
- Many different approaches to partially automate the process
 - Clio Query Discovery [MHH00]
 - Tupelo [FIWy06]
 - Integration Patterns [Gö05a]



Clio Query Discovery – Overview

- Clio is a combined tool for schema matching and mapping
- Creates executable mappings as SQL/XQuery statements for use in FDBMS
- Uses *value correspondences (VCs)*:
 - Essentially complex 1:n matches
 - A value correspondence v_i is a tuple (f_i, p_i) with
 - a *function* f_i describing how to derive a certain target attribute B from a set of source attributes A_k (and possibly from source metadata):
 $f_i: \text{dom}(A_1) \times \text{dom}(A_2) \times \dots \times \text{dom}(A_q) \rightarrow \text{dom}(B)$
 - a *filter* p_i indicating which source values should be used:
 $p_i: \text{dom}(A_1) \times \text{dom}(A_2) \times \dots \times \text{dom}(A_q) \rightarrow \text{boolean}$
 - Note: function and filter of a correspondence can be defined on different sets of attributes
- Idea: Divide the set of value correspondences V into subsets each of which determines one way to compute a given target relation T_k



Clio Query Discovery – Algorithm

- Consists of four distinct phases
- For each target relation T_k
 1. Partition V into *potential candidate sets* $\{c_1, \dots, c_p\}$ that contain *at most* one VC per attribute of T_k :
 - The c_i need not be disjoint
 - A c_i is called *complete* if it includes a VC for *every* attribute in T_k
 - Prefer **complete** potential candidate sets, and further prefer those that **use the smallest set of source relations**
 - Prune potential candidate sets that are subsets of another
 - Incomplete candidate sets are considered, as not every target attribute might have a VC
 2. Prune those potential candidate sets that cannot be mapped to a “good” query
 - To create a query, a way of **joining the source relations of the potential candidate set** is needed
 - Search for *join paths* (i.e. foreign keys) between the relations
 - If several join paths exist, use the one for which the estimated difference in size of an outer and an inner join is smallest, resulting in a minimum number of dangling tuples
 - If no join path exist, request the user to specify them
 - All potential candidate sets without a join path are removed
 - Result: *Candidate sets* for every target relation, representing different ways to obtain the values of the target relation
 - Each candidate set can be mapped to a Select-Project-Join(-Group-by-Aggregate) query



Clio Query Discovery – Algorithm (cont.)

3. Find sets of the candidate sets (*covers*) that contain every VC at least once
 - Determine a minimum cover, i.e., eliminate all covers from which candidate sets can be removed while still containing all VCs
 - Rank the remaining covers according to the inverse number of candidate sets they contain (less candidate sets means less queries)
 - For those with an equal number of candidate sets, choose those that have the largest number of target attributes in all candidate sets (i.e., minimize null values)
 - Present ranked covers as alternative mappings to the user
4. Create the query q for target relation T_k from the selected cover
 - For each candidate set c_i in the cover, create a candidate query q_i such that
 - All **correspondence functions** f_k mentioned in c_i appear in the **SELECT** clause
 - All **source relations** of the VCs in c_i appear in the **FROM** clause
 - All **predicates** p_i of the VCs in c_i appear in the **WHERE** clause
 - All **source relations needed for join paths** appear in the **FROM** clause and the **join predicates** appear in the **WHERE** clause
 - If c_i contains **aggregate functions**, all attributes not in the aggregate function are selected as **grouping attributes**. If the aggregate is in the correspondence function f_k , it is placed in the **SELECT** clause. If it is in a predicate, it is placed in a **HAVING** clause.
 - Combine all candidate queries q_i into q by the use of **UNION ALL**



Clio Query Discovery – Example

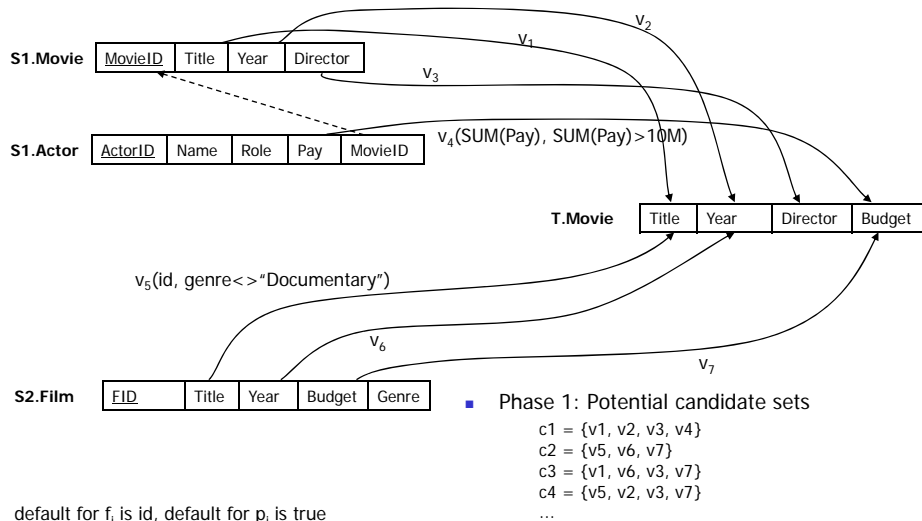

Clio Query Discovery – Example (cont.)

- Phase 2: Eliminate potential candidate sets that have no good query
 - e.g. c_3 and c_4 have no join paths, others are subsets
 - Only c_1 and c_2 remain
- Phase 3: Find all minimum cover (sets of candidate sets that contain all VCs)
→ $\{\{c_1, c_2\}\}$
- Phase 4: Create candidate queries and combined query:

```
q1 { SELECT Title, Year, Director, SUM(Pay)
    { FROM S1.Movie m, S1.Actor a
    { WHERE m.MovieID = a.MovieID
    { GROUP BY Title, Year, Director
    { HAVING SUM(Pay) >10M
    UNION ALL
q2 { SELECT Title, Year, null, Budget
    { FROM S2.Film
    { WHERE genre <> "Documentary"
```



Deployment



Information Integration Middleware

- Multitude of middleware systems and architectures
 - Major approaches:
 - logical (virtual) integration
 - federated DBMS, multi-database systems
 - data processing specified using SQL, XQuery, ...
 - physical (materialized) integration
 - data replication, data warehousing, ETL (extract-transform-load), XML transformations, message brokering
 - utilizes ETL "scripts" based on (product-specific) dataset processing operators
 - Technologies
 - differ in terms of
 - functional properties (data processing specification, expressive power)
 - non-functional properties (target response times, data currency)
 - are often used in combination, involving several product platforms
 - Complex development /deployment tasks!
No common language for platform-independent integration plan!



An Abstract Data Set Processing Model

- Idea: provide a generic model for describing data set processing
 - abstract data set model
 - structural properties (schema): flat & nested relations, XML
 - data access properties: associative vs. sequential, persistent vs. transient, sorting/grouping properties, update properties ...
 - should also cover data streams, XML feeds
 - abstract processing model
 - platform-independent data processing operators
 - starting point: extended relational algebra
 - should also cover XML processing, data cleansing operations, propagation of source updates
 - used to specify an integration plan in a platform-independent manner



Major Advantages

- Modeling, visualizing, and reasoning about data processing independent of a deployment platform
- Top-down development
 - choice of platform often based on non-functional requirements
 - suggested by system, or determined by user
 - automatic generation of target platform artifacts during deployment
 - ETL scripts, queries and view definitions, replication setup, ...
 - initial load vs. incremental load (considering updates, insertions, deletions on data sources)
- Optimization opportunities
 - logical (algebraic) optimization
 - choice of deployment platform(s) for operator subgraphs
 - e.g., push part of processing into the DBMS at the source or target
 - platform-dependent optimization
 - e.g., chose the most suitable ETL operator
- Active area of research



Orchid

- Research project at IBM Almaden [HDWRZ08]
- Links different phases, levels of abstraction in information integration
 - Mappings, mapping interpretations (→ Clio)
 - Abstract data set processing model (OHM – Operator Hub Model)
 - Deployment platforms
 - main focus initially on ETL
- In parts already reflected in IBM products
 - IBM Information Server v8.0.1



Orchid Architecture

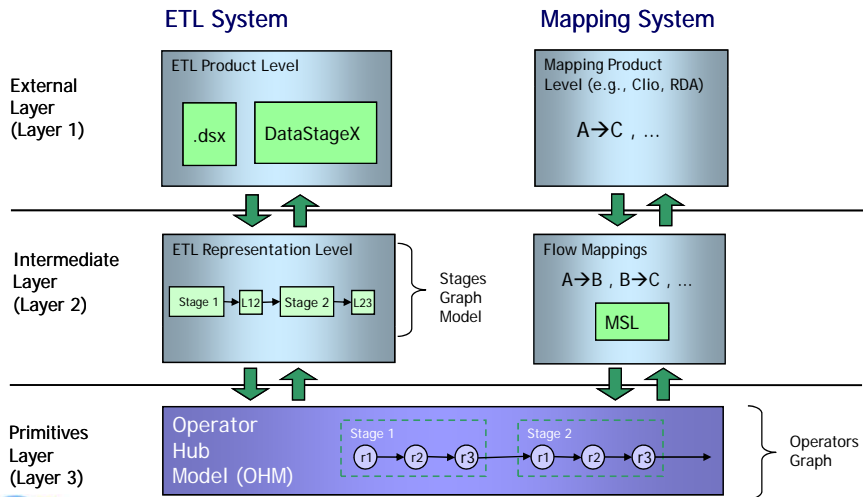

OHM Operators

- Based on Relational Algebra operators
 - Initial focus was relational data transformation
 - Simple and well-known semantics (30+ years of history)
 - Plenty of well-known query graph representations, query optimizations, query rewrite techniques.
- Main OHM operators:

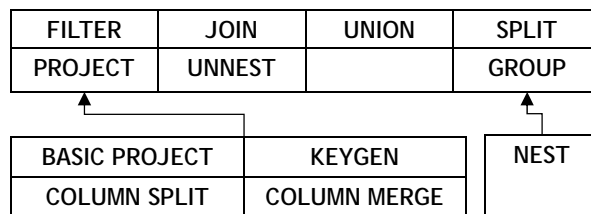

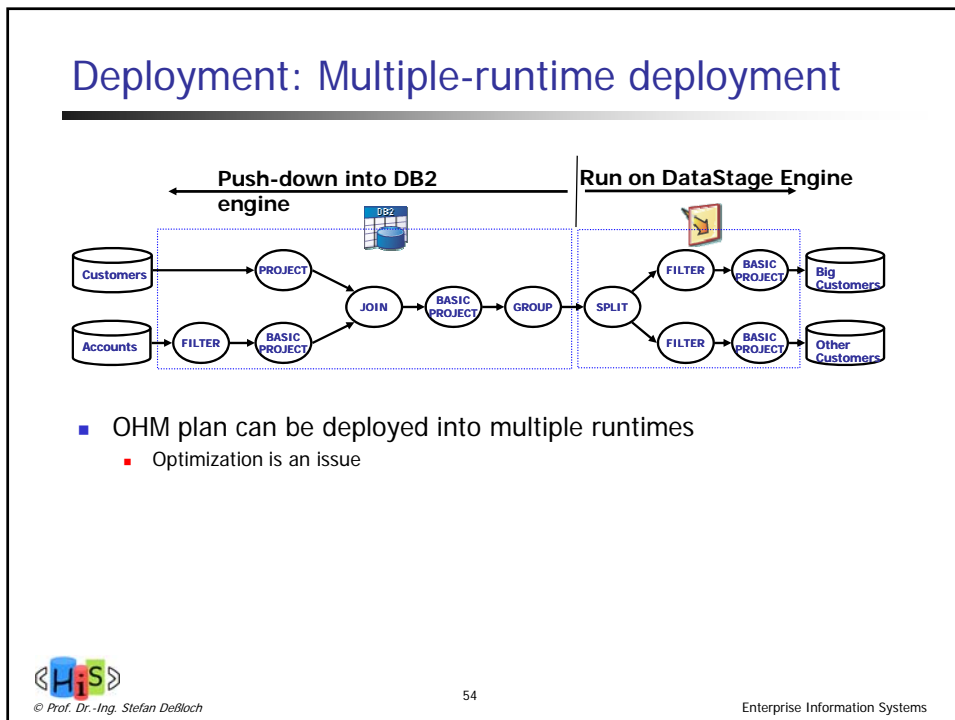
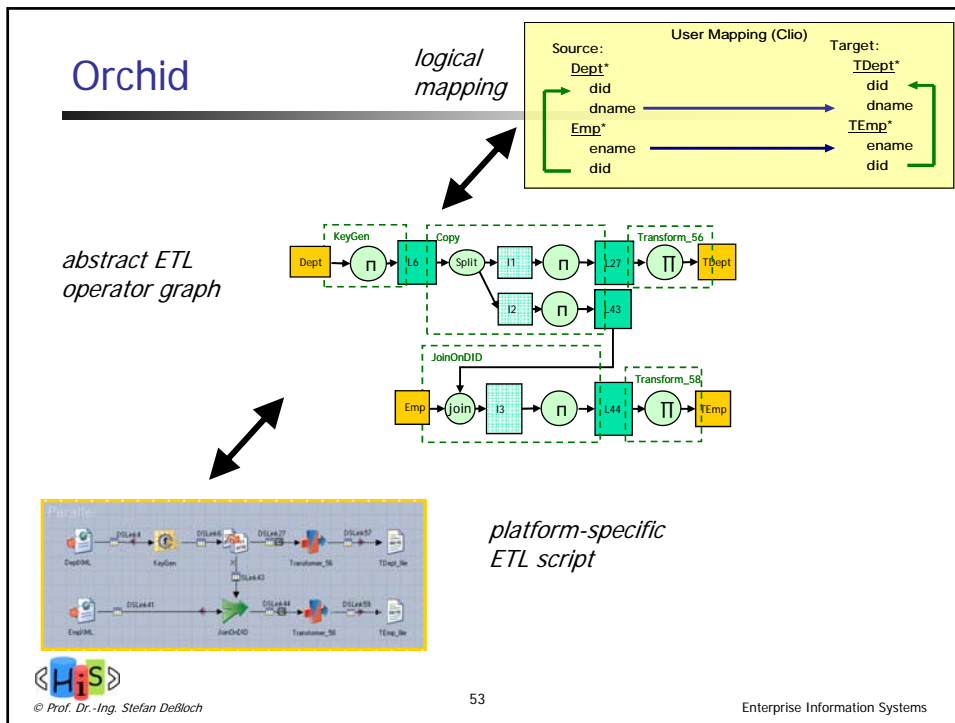

Supporting Incremental Loading [JoDe08]

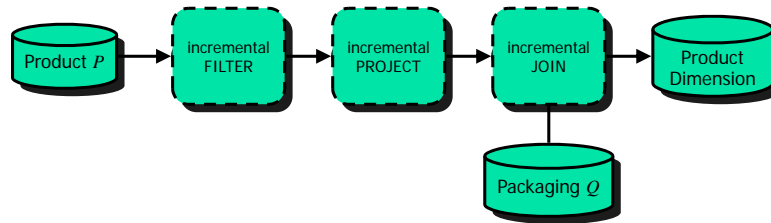

- OHM instance as starting point
- Replace basic OHM operators with *incremental* variants
- Incremental operators are composed of basic OHM operators
- Leverage Orchid's optimization and deployment facilities



Change Data Propagation

- Interface between Change Data Capture and Change Data Application
- Given CDC limitations, what CDA requirements are satisfiable?
- Given CDA requirements, what CDC limitations are acceptable?
- What data transformations are to be performed for change data propagation?

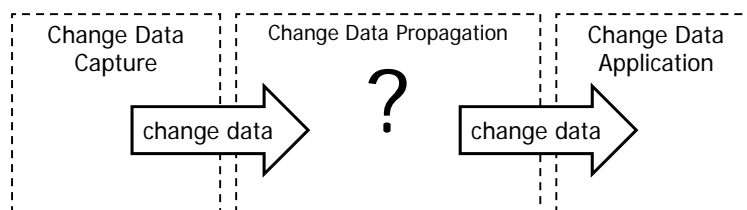

Change Data Model

- Given dataset D
change data is $(\Delta D, \nabla D, \boxplus D, \boxminus D)$
 - ΔD denotes insertions
 - ∇D denotes deletions
 - $\boxplus D$ denotes updates (current state)
 - $\boxminus D$ denotes updates (initial state)

- CDC limitations
- *Partial* change data results from CDC limitations
- Missing change data
- Indistinguishable changes

- Audit columns: $(\Delta D \cup \boxplus D)$ or $\Delta D, \boxplus D$
- Snapshot differentials: $\Delta D, \nabla D, \boxplus D$
- Log-based CDC: $\Delta D, \nabla D, \boxplus D, \boxminus D$



© Prof. Dr.-Ing. Stefan Deßloch

Enterprise
Information
Systems

Incremental OHM Instance

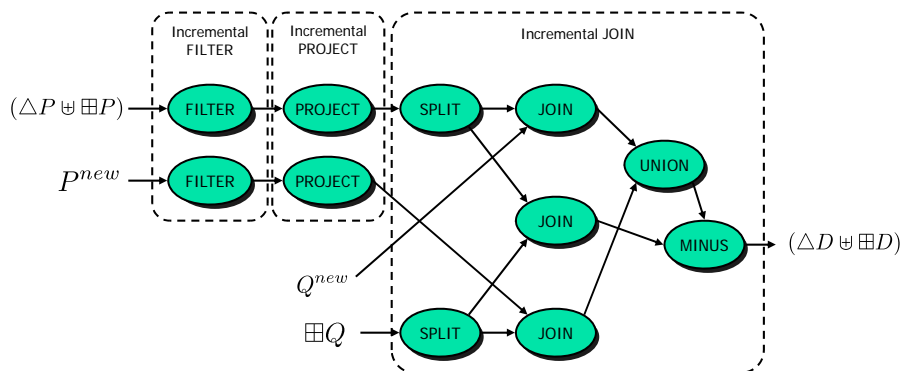

© Prof. Dr.-Ing. Stefan Deßloch

58

Enterprise Information Systems

Summary - Deployment

- Challenge: complexity of implementing an integration solution
 - approaches: virtual vs. materialized – or combinations thereof
 - different middleware platforms
 - complex to use
 - no common language for platform-independent integration plans
- Goal: support an abstract data and transformation model
 - platform-independent, top-down development
 - (cross-platform) optimization
- Orchid
 - Links mapping tools and transformation (ETL) platforms using operator hub model, OHM
 - Generates ETL scripts from mapping specifications (and vice versa)
 - Can deploy to combination of multiple platforms (e.g., DBMS pushdown + ETL)
- Incremental operators
 - Model for (partial) change data
 - Generation of incremental load processes based on
 - CDC limitations , CDA requirements, Source properties and schema constraints
 - Leverage Orchid's deployment facility



Model Management



Model Management

- Observation: All activities in information integration require handling of
 - Complex metadata-like design artifacts ("Models") and
 - Relationships among models ("Mappings")
 - "Model Management"
- Similar challenges in other areas:
 - Software Engineering (Change Mgmt, Round-trip Engineering, Model-driven Development)
 - Workflow Management (Process Modeling and Optimization)
 - All different kinds of "model-centric" applications
- Today: model management applications built from scratch
 - High effort, error-prone, time-consuming
 - c.f. data management before the availability of generic DBMSs
- Idea: Identify commonalities among model management activities with resp. to
 - Model & mapping representation
 - High-level operations on models & mappings
- Goal: Build a *Generic Model Management System* (GMMS) [BHP00]
 - Provides core functionality common to different model management applications that is adaptable to their respective specific requirements
 - Hope to repeat the success story and impact of generic DBMSs



Models and Mappings

- Models
 - Describe aspects of the application domain and/or of the system we are building
 - e.g. E/R models, schemas, UML diagrams, workflow specifications
- Mappings
 - Special kinds of models that indicate how elements in different models are related
 - Mappings can be directed or undirected
 - Many different methods to represent these relationships, with great variation in expressiveness and complexity
 - Basic semantic correspondences – only indicate that elements are related in "some way", not how
 - Value correspondences – specify how instances in a target model (e.g. tuples in a relational schema) are derived from instances of a source model, but do not indicate which and how source instances are to be combined
 - "Executable" mappings (≈ integration plans) – expressed in a language which can be directly executed by some runtime environment (e.g., SQL views in a federated DBMS, ETL scripts, ...)
- Challenges:
 - Find a common "language" to represent these many different kinds of models and mappings within a GMMS (a "data model for models")
 - Identify a mapping language which strikes a balance between expressiveness and ease of handling



Model Management Operations

- **ModelGen:** $\text{modelA}_{DM1} \rightarrow \text{modelA}'_{DM2}, \text{map}_{AA}$
 - Given a model in one data model DM1, create an "equivalent model" in another datamodel DM2, plus a mapping between input and output model
- **Match:** $\text{modelA}, \text{modelB} \rightarrow \text{map}_{AB}$
 - Identify semantic (or value) correspondences between two models (=schema matching)
- **Merge:** $\text{modelA}, \text{modelB}, \text{map}_{AB} \rightarrow \text{modelC}, \text{map}_{AC}, \text{map}_{BC}$
 - Given two models A and B connected by a mapping, determine a merged model C (=schema merging)
- **Compose:** $\text{map}_{AB}, \text{map}_{BC} \rightarrow \text{map}_{AC}$
 - Given two mappings, one from a model A to B, the other from B to C, create a single mapping going directly from A to C
- **TransGen:** $\text{map}_{AB} \rightarrow \text{map}^X_{AB}$
 - Given a non-executable mapping (e.g., value correspondences), create an executable mapping from it
- Many more proposed operations: Copy, Invert, Extract, Union, ...
- **Problems:**
 - Model management operators
 - are complex, often heuristic, or inherently semi-automatic
 - usually don't have a clearly defined semantics or outcome
 - At least some aspects of many model management operators will depend on the actual metamodel(s) of the models involved



Rondo – A Model Management System

- **Rondo [MRB03]**
 - First reasonably complete Model Management System
 - Models represented as graphs stored in a relational schema
 - Scripting to connect model management operators
 - Supports only simple mappings ("morphisms") equivalent to 1:1 semantic correspondences
 - Considerably eases the implementation of many model management operators, but
 - Applicable only for model management scenarios where executable mappings are not relevant
 - Provides implementations for some of the heuristic operators:
 - Match: Similarity Flooding Algorithm
 - Merge: Rondo Merging Algorithm discussed in this chapter
 - Many basic model management operators can be implemented declaratively by simple SQL queries on the relational representation of the graphs



Model Management Scenario – Bottom-up Integration

- Mission: Create an integrated view V over two data sources A and B .
- Could be handled with the following (simplified) model management "script":

```

 $M_{AB}$  := Match(A, B)
 $(V, M_{AV}, M_{BV})$  := Merge(A, B,  $M_{AB}$ )
 $M_{ABV}$  := Union( $M_{AV}, M_{BV}$ )
 $M_{ABV}^X$  := TransGen( $M_{ABV}$ )
    
```

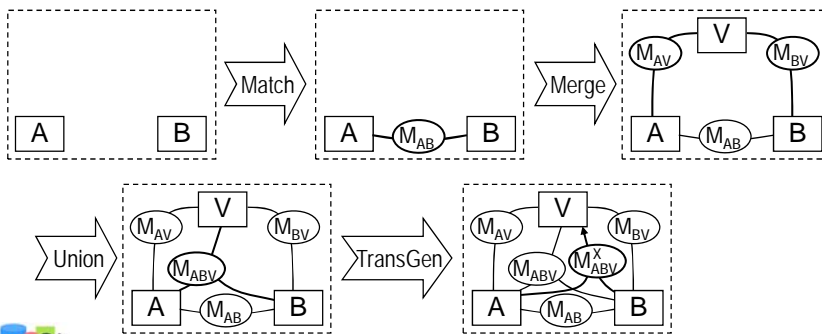

© Prof. Dr.-Ing. Stefan Deßloch

65

Enterprise Information Systems

Paladin Model Management Framework – Motivation

- II involves many different tasks that require handling of data and metadata
 - For each II task, a plethora of different mechanisms, languages and tools exist with individual advantages and drawbacks
 - No single "swiss army knife" to tackle all integration problems
 - A practical integration scenario requires several tools, but
- Interoperability between tools is limited
 - No uniform representation of metadata (and data)
 - ➔ Requires a lot of conversions (not always possible)
 - Very different mechanisms to describe data transformations
 - descriptive (query languages, algebras)
 - procedural/declarative/functional programming languages (XSLT, ETL scripts, shell scripts...)
 - parameterized black boxes (wrappers)
 - No single mechanism is powerful enough to express a complete source-to-target data transformation (*integration plan*)
 - ➔ Actual integration plans have to be described by combining several mechanisms
 - ➔ Integration plans are tightly coupled to a type of runtime system



© Prof. Dr.-Ing. Stefan Deßloch

66

Enterprise Information Systems

Paladin Model Management Framework – Concepts

- Embraces the idea of generic model management
 - Provide reusable operators or *components* to support complex operations on models and mappings
 - Allow exchange of models and mappings between components by providing a suitable internal representation
 - Ease the implementation of operators
 - Model management is a complex problem!
 - Existing implementation technologies/languages ill-suited for specific model management application
 - ➔ Even less suitable for a generic implementation of model management operators!
 - Paladin framework allows developers to use different (existing) implementation languages depending on the task at hand (or on personal preferences...!)
 - Imperative, object-oriented code (Java)
 - Declarative manipulation on relational or XML representations of models with SQL or XQuery
 - Already better than being forced to use *one* language, but
 - Imperative code uses a too fine-granular, *one-object-at-a-time* paradigm and requires complex navigational code ➔ Developers occupied with "How" instead of "What"
 - Existing declarative languages operate on the "wrong" data model (relations, trees) for model management (graphs!) ➔ Developers struggle with impedance mismatch
- ➔ Provide a new declarative, set-oriented and natural (graph-oriented) language paradigm
- ➔ Paladin Graph Transformation Language



Paladin Framework – Architecture

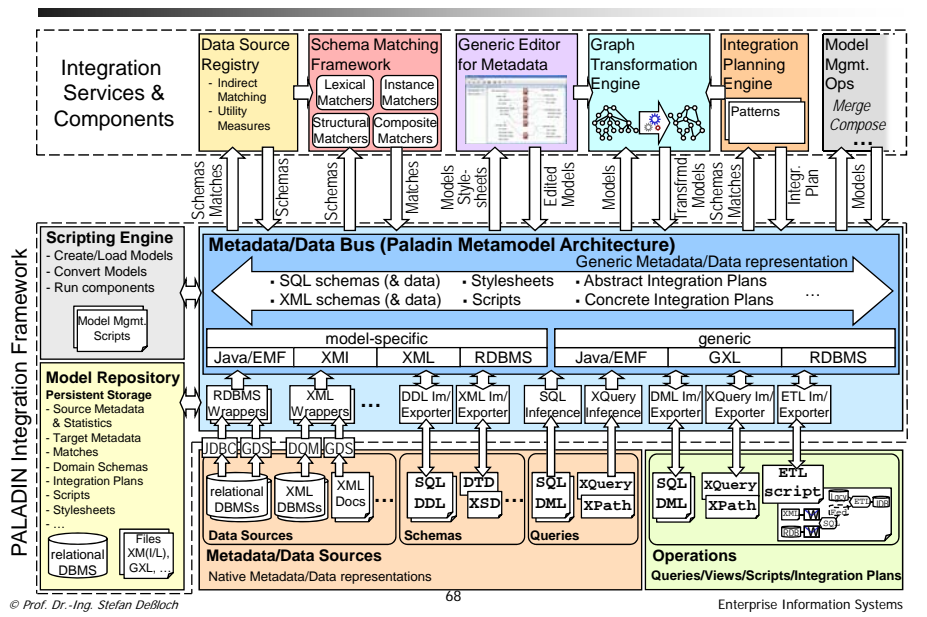

Paladin Metamodel Architecture (PMA)

- Goal: An integrated model for data, metadata and operations to ease exchange between framework components [GoDe07]
- Graph-based representation of data and metadata that is
 - extensible (can support new metamodels)
 - lossless (support special features of different metamodels)
 - generic (capture common properties among different metamodels)
 - efficient (should not be overly verbose, especially for data representation)
 - natural
- Generic representation of arbitrary data and metadata management operators
 - All operations manipulate the graph structure of data and metadata represented in PMA
 - Idea: express the effects of operators as graph transformations
 - Chain transformations to obtain one consistent representation for source-to-target integration plans



Summary - Model Management

- Generic model management
 - Provides core functionality common to different model management applications that is adaptable to their respective specific requirements
 - Generic operators
 - ModelGen, Match, Merge, Compose, TransGen, ...
- Vision of generic model management has already contributed to
 - Classify existing research and clarify the heterogeneous terminology
 - Identify critical problems that need the research community's attention
 - Produce promising prototypes
- Despite ~8 years of research, many unresolved challenges remain:
 - Expressiveness and extensibility of (graph-based) model representation
 - Generic integration plan language with sufficient expressiveness and good theoretical properties
 - Understanding of the semantics of many operators
 - Dealing with heuristic operators and the need for human intervention, supervision
 - Implementation techniques and paradigms for generic model management operators
- Great research opportunities!



Information Integration in Dynamic Environments



Differences to Classical Integration Scenarios

- Classical integration scenarios
 - Integrate data within organizations (department, company)
 - Limited degree of heterogeneity (as data sources come from similar context)
 - Assume a static, closed-world environment
 - Well-known data sources
 - Full administrative control over all involved data sources (i.e., very limited data source autonomy)
 - Well-defined and fixed user/application requirements
- Dynamic integration scenarios
 - Integrate data across organizational boundaries
 - Higher degree of heterogeneity
 - Technical/Data model: Choice of technology not limited by company policy
 - Semantic: data sources come from completely different backgrounds
 - Dynamic, open-world environment
 - Data sources come and go, or change their properties (export schema)
 - Several orders of magnitude more data sources
 - More and more diverse user requirements ("integration to the masses")
 - e.g. data grids, mashups



Challenges

- Requires a top-down approach to integration
 - Methods to specify a target schema for non-expert users
- Find the best sources for a given information requirement
 - Methods to discovery the most useful sources out of a very large number of candidates
- Reduce the human interaction needed for integration planning
 - Better automatic schema matchers
 - Improved (Semi-)automatic creation of integration plans from input schemas, target schema, and mappings across all kinds of data sources and data models
- Flexibility in the deployment of integration plans to different runtime environment
 - Users might not have the resources to host their own integration system
 - Hosting provided as service
 - Mechanisms for flexible redeployment needed to allow migration to different provider (due to cost, availability)



Dynamic Integration Process – Challenges

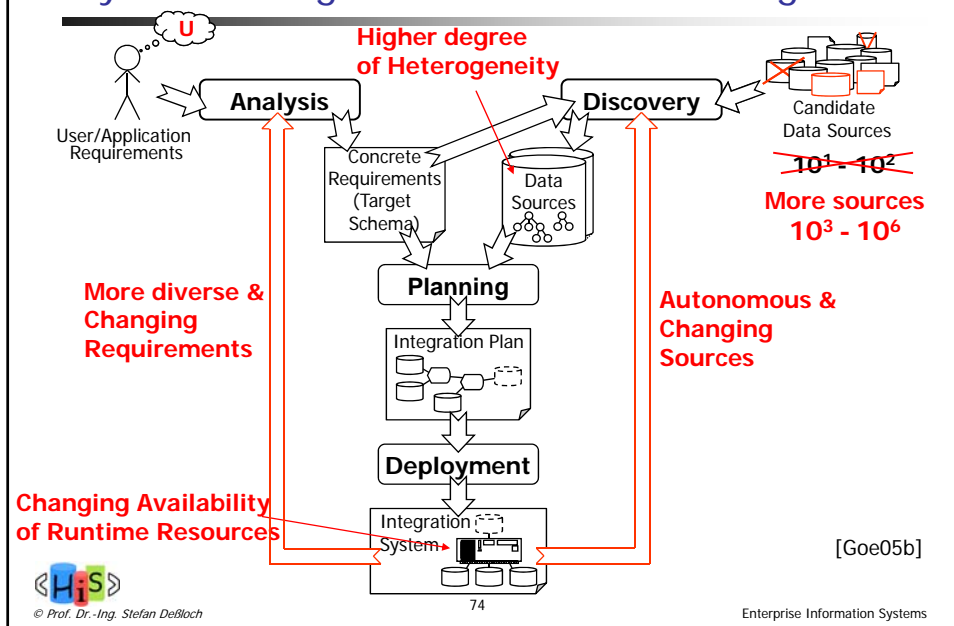

Discovery

- Begin integration planning with 10^4 - 10^6 sources?
 - Need to preselect the *most useful* data sources
- What makes a data source useful?
 - ➔ Covers *similar concepts* as the target schema
- How are similar concepts identified (in the presence of heterogeneity)?
 - Schema matching!
 - But matching target schema with 10^4 - 10^6 sources is infeasible
 - Idea: Indirect schema matching via *domain schemas*
(Compare to *Compose* operator!)
 - Matches can be created offline during data source registration
 - At discovery time, only the target schema has to be matched against (few!) domain schemas
 - Direct matches can be inferred assuming transitivity
 - Use inferred matches to calculate utility measures for the sources

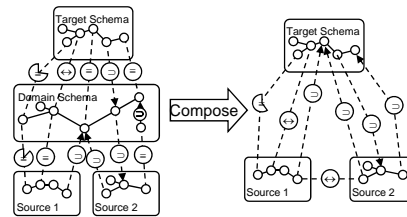

Change Management (CM) in Large-Scale Information Infrastructures

- Information infrastructures consist of dozens, hundreds or more single systems
 - Each system has *metadata* describing it
- Complex dependency structures between single systems
 - Federations, materialized views, workflows, replication, ...
- Local changes can impact a large part of the whole infrastructure
 - System failure, wrong results, data corruption, ...
 - Caused by schema changes, "bug fixes", changing file system structures, ...
- No central point of responsibility
 - Different departments, B2B scenarios, ...
- Heterogeneous and dynamic environment
 - Systems keep changing all the time
 - Metadata is provided in many different formats and models
- How to keep everything running?



Change Management and Change Impact Analysis (CIA)

- Organization
 - **Strict Change Management Process:** Adherence to a strict process ensures that no faults occur.
 - **No/Ad-hoc Change Management Process:** Without adherence to a CM process, probability of faults increases.
- CIA Time
 - **Preventive:** Analyze the impacts of changing a system before applying the changes.
 - **Reactive:** Impact analysis is done at some point in time after changes are applied.
- CIA Automation:
 - **Automatic:** The complete, global impact analysis as well as adapting systems to changes can be done automatically.
 - **Semi-Automatic:** At least some manual intervention is needed, either in CIA or in adaptation.
 - **Manual:** Everything has to be done manually.



Caro – Basic Idea

- A *strict* change management process, with *fully automated, preventive* CIA and *automatic* adaptation of impacted systems is not realistic.
 - The "human in the loop" will bypass uncomfortable procedures and processes, and enforcing them is not practicable.
 - High heterogeneity doesn't allow for a full automation.
 - Absence of centralized management and distributed responsibilities hinder preventive CIA.
- The best we can get is an approximation of the optimal case, on a "best effort" basis:
 - No assumptions regarding CM processes
 - Do preventive CIA if possible, and try to do reactive CIA as soon as possible after a change is applied.
 - Enable the use of Caro as a distributed system, to account for different responsibilities in different areas of the information infrastructure.



Caro – Goals

- Provide a model
 - to represent arbitrary system metadata in a generic way
 - to represent the dependencies between systems
- Provide algorithms for change impact analysis
 - locally within a system, and globally over system boundaries
- Provide means for preventive reactive change impact analysis
 - An editor to manually edit metadata, and let the analysis component calculate what impact these changes would have
 - Metadata Agents which observe information systems for changes, so they do not go undetected for a long time
 - Directives (system shutdown, administrator notification, automatic adaptation) to execute when changes are detected
- Provide a central management component
 - to store metadata of participating systems
 - to do global change impact analysis and coordinate the various metadata agents



© Prof. Dr.-Ing. Stefan Deßloch

79

Enterprise Information Systems

Prof. Dr.-Ing. Stefan Deßloch
AG Heterogene Informationssysteme
Geb. 36, Raum 329
Tel. 0631/205 3275
dessloch@informatik.uni-kl.de



Data Integration

- Data Quality Problems
- Causes and Consequences
- Data Cleaning



Data Quality

- All approaches discussed so far only resolve heterogeneity regarding the schemas/metadata of the data sources
- Problems in the data itself remain to be resolved:
 - Erroneous data (values outside domain, violated constraints)
 - Data inconsistencies (Contradictions across and within a data source)
 - Duplicates (Are two tuples from different sources referring to the same real world object?)
 - Completeness (Does a data source deliver all data for a concept?)
 - Credibility (Is the source reliable, can the data be trusted?)
 - Timeliness (Is the data up-to-date?)
- Many problems are similar to those for schema integration
 - Synonyms, homonyms – semantic heterogeneity
 - Do the tables "Person" and "Pers" refer to the same concept? \approx
 - Do "Gottlieb-Daimler-Straße" and "Gottl.-Daiml.-Str" refer to the same object?
 - Considerable degree of uncertainty
 - Scale of the problem several orders of magnitude larger:
 - $\sim 10^2$ - 10^3 schema elements, but 10^2 - 10^9 ++ instances
 - Resolving data quality ("Data Cleaning") problems is extremely expensive
 - Today usually only done in replicating/materialized integration systems



Classification of Data Quality Problems

- based on [RaDo00, LeNa07]

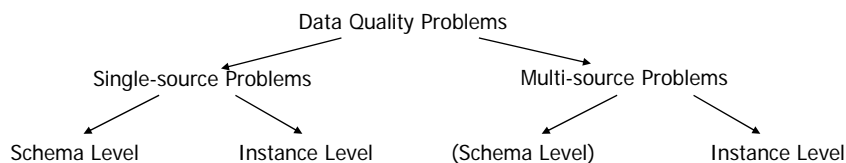

- Allocation of problems to categories is not always unambiguous
- Instance level multi-source problems were previously subsumed as syntactic heterogeneity
- Schema level multi-source problems were discussed in previous sections (forms of heterogeneity)



Single-source schema level problems

- Lack of integrity constraints: data source cannot enforce application constraints that are not made explicit using the facilities of the data model
 - No unique constraints → Duplicate values
 - No enforced referential integrity → inconsistent references
 - Inadequate typing (e.g. String to represent dates) → invalid values
 - Unspecified dependencies → dependency violations
 - e.g. age = \$today - birthdate
 - NOT NULL constraint omitted → missing values
- Bad Schema Design
 - e.g., redundancies in schema caused by denormalization
 - Inconsistencies due to insert/delete/update anomalies



Single-source data level problems (I)

- Typos (e.g. "Gremany")
 - can be resolved by spellcheckers or domain experts
- Dummy values to "outwit" constraints
 - e.g. ZIP code 99999 used for "unknown value"
 - "John Doe" for an unidentified person
 - often resolvable for domain experts, but dummy values often not used consistently
- Wrong values – value does not properly represent the real world
 - e.g. Movie(Title="Lord of the Rings", Year="1928")
- Deprecated values
 - e.g. Germany(Founded="1949", Chancellor="Gerhard Schröder")
- Cryptic values
 - encoded or abbreviated data values
- Embedded values
 - values embedded in other fields to compensate for missing fields
 - e.g. Movie(Title="Fight Club, 1999")
- Wrong allocation
 - correct value entered into wrong field/swapped values
 - e.g. Actor(Name="Tyler Durden", Role="Brad Pitt")



Single-source data level problems (II)

- Wrong reference
 - reference to an existing, but the wrong object
- Contradictory values
 - Address(City="Kaiserslautern", ZIP="12345")
 - Student(Name="Christian Meier", Gender="f")
- Transpositions
 - different sequences used for data items within a field
 - Person("Hans Meier"), Person ("Müller, Karl")
- Duplicates
 - two or more data records representing the same real world object
 - techniques for duplicate detection and resolution
 - a problem with many names: record matching, entity resolution, instance disambiguation
 - Data Conflicts
 - Duplicates contradict each other
 - Movie(Title="Lord of the Rings", Year="1978") vs. Movie(Title="Lord of the Rings", Year="2001")
 - How to separate two duplicates with a conflict from two correct entries?



Multi-source data level problems

- Differentiation is difficult – therefore, multi-source data level problems
 - are new kinds of problems that *typically* occur during integration of several source (but can also be present in a single source)
 - include many of the single-source data level problems, e.g. Transpositions, Duplicates when they occur after integration
- Contradictory values
 - data from different sources contradict each other (≠Conflict!)
 - e.g. Source1.Person(ID="1234", Age="47") vs. Source2.Person(ID="1234", DoB="1983-06-03")
- Differing representations
 - e.g. Source1.Emp(ID="1234", Job="Sales Mgr.") vs. Source2.Emp(ID="1234", Job="S24")
- Different physical units
 - e.g. Source1.Person(Name="Herbert Meier", height="183") [cm] vs. Source2.Person(Name="Herbert Meier", height="72") [inches]
- Different precision
 - e.g. Source1.Movie(Title="Fight Club", runtime="2h19min") vs. Source2.Movie(Title="Fight Club", runtime="2h19min12sec")
- Different levels of details
 - e.g. "all actors" vs. "only main cast"



Handling Data Quality Problems

- Phase 1: Data Scrubbing (individual records)
 - Resolve errors within individual tuples/data items
 - Normalise data
 - unify case, stemming, stopword removal, acronym expansion
 - Formatting: unify date formats, person names ("H. Schmidt" vs. "Schmidt, H."), addresses
 - Conversions: convert numerical values to a single unit
 - simple for physical values (e.g.: length measures: conversion between m, cm, inch etc. is constant)
 - difficult for currencies! (which exchange rate to use? Today's? The rate at the (maybe unknown) insertion date?)
 - Remove outliers
 - test if data conforms to expectations (expressed as constraints, „sanity checks“)
 - perform lookup in reference data (e.g., telephone directories)
 - Violated constraints
 - Test referential integrity



Handling Data Quality Problems (II)

- Phase 2: Entity Resolution
 - Resolve problems involving multiple records
 - Detect duplicate entries
 - Pairwise comparison of tuples, calculation of a similarity value
 - If similarity above threshold -> duplicate detected
 - False positives and negatives
 - Determine quality of duplicate detection using
 - precision (percentage of identified duplicates that are really duplicates)
 - recall (percentage of actual duplicates found)
 - Very expensive: $O(n^2)$ (possibly very complex) comparisons
 - Partition data and only compare tuples within a partition
 - Data Fusion
 - Combine detected duplicates into one consistent tuple
 - Equality – tuples agree on all attributes
 - Subsumption – a tuple t_1 subsumes tuple t_2 , if it has less null values than t_2 and agrees with t_2 on all non-null values
 - Complementation – two tuples complement each other, if none subsumes the other and if for each non-null value of one tuple, the other tuple either has a null value or the tuples agree on the value
 - Conflict – all other situations represent a conflict, i.e., if two duplicate tuples do not agree on at least one attribute value
 - Subtlety of null value semantics (unknown, inapplicable, withheld ...)



Data Cleaning – Summary

- Creation of data cleaning mappings requires human interaction
 - Tools can suggest reasonable mappings
- Many errors can not be resolved “in batch”
 - Either we decide for one source, possibly introducing errors and losing correct data
 - Or we do not make a decision and leave conflicting duplicates in the result
- Duplicate detection and resolution introduces uncertainties
- Actual validity of individual tuples cannot reasonably be checked for all kinds of data
 - Only limited availability of reference data for specific application concepts (e.g. addresses)



References (I)

- [BHP00] Bernstein, P. A.; Halevy, A. Y. & Pottinger, R. A. : A vision for management of complex models
SIGMOD Record, ACM Press, 2000, 29, 55-63
- [BLN86] Batini, C.; Lenzerini, M. & Navathe, S.B.: A comparative analysis of methodologies for database schema integration
ACM Comput. Surv., ACM Press, 1986, 18, 323-364
- [CRF03] Cohen, W.W.; Ravikumar, P. & Fienberg, S.E.: A Comparison of String Distance Metrics for Name-Matching Tasks.
IWeb, 2003, 73-78
- [FIWy05] Fletcher, G.H.L. & Wyss, C.M.: Relational data mapping in MIQIS
SIGMOD 2005, ACM Press, 912-914
- [FIWy06] Fletcher, G.H.L. & Wyss, C.M.: Data Mapping as Search.
EDBT, 2006, 95-111
- [GoDe07] Gores, J. & Dessloch, S.: Towards an Integrated Model for Data, Metadata, and Operations
BTW 2007, to appear
- [Goe05b] Gores, J.: Towards Dynamic Information Integration
First VLDB Workshop on Data Management in Grids (DMG05), Trondheim, 2005, 16-29
- [Goe05a] Gores, J.: Pattern-based Information Integration in Dynamic Environments
9th International Database Engineering Applications Symposium (IDEAS 2005), 125-134
- [GPZ01] Greco, S.; Pontieri, L. & Zumpano, E.: Integrating and Managing Conflicting Data
PSI '02, Springer-Verlag, 2001, 349-362
- [HDWRZ08] Hernandez, M.; Dessloch, S.; Wisnesky, R.; Radwan, A.; Zhou, J.
Orchid: Integrating Schema Mapping and ETL
Proc. 24th International Conference on Data Engineering, April 7-12, 2008, Cancún, México
- [HeSt98] Hernandez, M.A. & Stolfo, S.J.: Real-world Data is Dirty: Data Cleansing and The Merge/Purge Problem
Data Mining and Knowledge Discovery, 1998, 2, 9-37
- [JoDe08] Jörg, T.; Deßloch, S.: Towards Generating ETL Processes for Incremental Loading
12th Int. Database Engineering & Applications Symposium (IDEAS 2008), 2008
- [LeNa07] Leser, U. & Naumann, F.: Informationsintegration
dpunkt Verlag, 2007
- [LSS96] Lakshmanan, L.V.S.; Sadri, F. & Subramanian, I.N. Vijayaraman, T.M.
SchemaSQL: A Language for Interoperability in Relational Multidatabase Systems
VLDB 1996, 239-250



References (II)

- [LSS01] Lakshmanan, L.V.S.; Sadri, F. & Subramanian, S.N.:
SchemaSQL: An extension to SQL for multidatabase interoperability
Database Systems, 2001, 26, 476-519
- [MRB03] Melnik, S.; Rahm, E. & Bernstein, P. A.
Rondo: A Programming Platform for Generic Model Management
SIGMOD 2003
- [RaBe01] Rahm, E. & Bernstein, P.A.: A survey of approaches to automatic schema matching
VLDB Journal, 2001, 10, 334-350
- [RaDo00] Rahm, E. & Do, H.H.: Data Cleaning: Problems and Current Approaches.
IEEE Data Eng. Bull., 2000, 23, 3-13
- [PoBe03] Pottinger, R. & Bernstein, P.A.: Merging Models Based on Given Correspondences.
VLDB, 2003, 826-873
- [MBR01] Madhavan, J.; Bernstein, P.A. & Rahm, E.: Generic Schema Matching with Cupid
The VLDB Journal, 2001, 49-58
- [MGR02] Melnik, S.; Garcia-Molina, H. & Rahm, E.:
Similarity Flooding: A Versatile Graph Matching Algorithm and Its Application to Schema Matching.
ICDE 2002, 117-128
- [MH00] Miller, R.J.; Haas, L.M. & Hernández, M.: Schema Mapping as Query Discovery
VLDB 2000, Morgan Kaufmann, 2000, 77-88
- [ScSa05] Schmitt, I. & Saake, G.
A comprehensive database schema integration method based on the theory of formal concepts.
Acta Inf., 2005, 41, 475-524
- [WyRo05] Wyss, C.M. & Robertson, E.L.: Relational languages for metadata integration
ACM Trans. Database Syst., ACM Press, 2005, 30, 624-660
- [WyRo05b] Wyss, C.M. & Robertson, E.L.: A formal characterization of PIVOT/UNPIVOT
CIKM 2005, ACM Press, 602-608

